

Vanity
BY DESIGN

Mac
collection

20
24

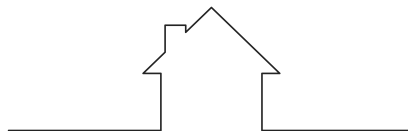

House Collection

Mac 900 Single

Mac 1500 Double

Chelsea 460

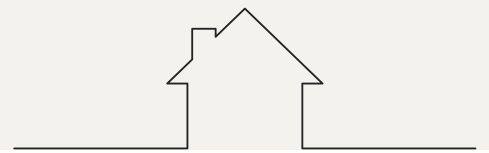

House Collection



Mac 900 Single



Mac 1500 Double



Chelsea 460

Cabinet Finish

Choose your Paint Finish | Custom Paint

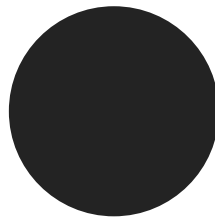

Black

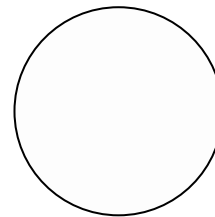

White

Bench Top

Subject to availability and chosen design



Snow-Blanc
Crystalline Silica-Free
(Engineered Stone)



Ayla
Crystalline Silica-Free
(Engineered Stone)

Basin

Client to Nominate



Tommy White or Black
(Standard)



Mac collection

– Our Mac range is a contemporary design with a slatted textural detail and seamless handle. Inspired by modern Australian architecture, Mac is a true reflection of our relaxed beach to city lifestyle.

Mac 900 | Single Basin

900 Length x 460 Depth

Mac 1500 | Double Basin

1500 Length x 460 Depth



Mac

Mac 900 Single - 2024 (Wall Hung)

Cabinet Size: 880mm (L) X 450mm (D) X 500mm (H)

Top Size: 900mm (L) X 460mm (D) X 20mm (H)

Type: Wall Hung

Basin: Client to nominate

No Tap Holes, Tapware to be wall-mounted

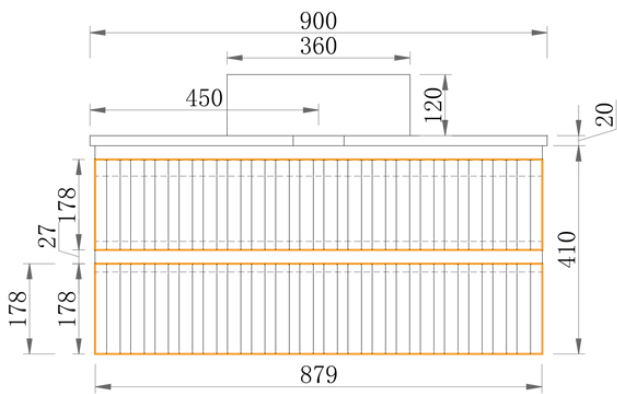
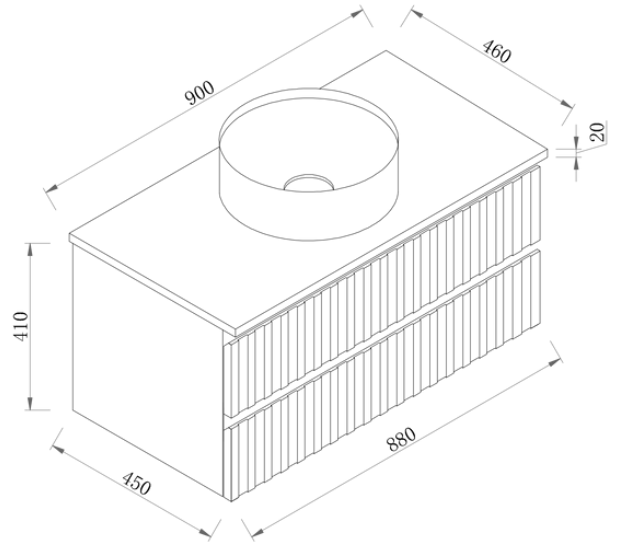

Front Elevation

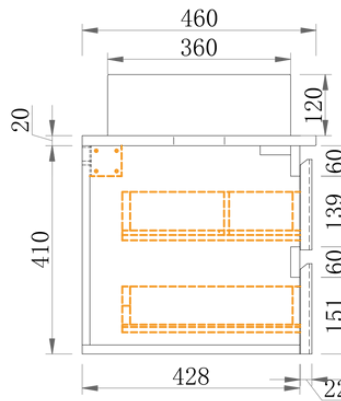

Section Side

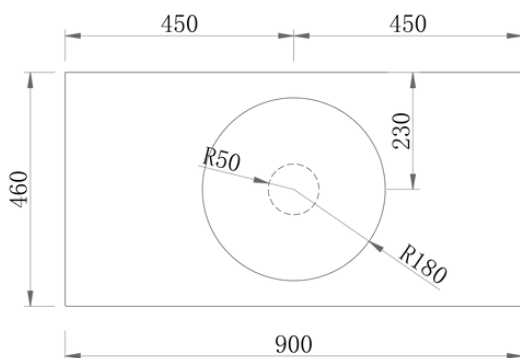

Top View

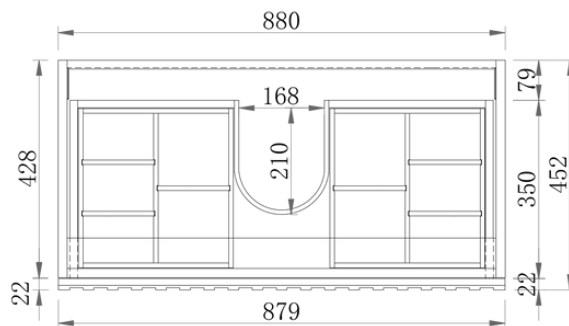

Section Top - Drawer Inserts

Notes:

- Wastes and faucets are not included.
- Vanity unit must be installed by a qualified tradesmen - Failure to do so will void the warranty.
- Plumbing fixtures must be installed by a qualified plumber - Failure to do so will void the warranty.
- Warranty information: 5 years on cabinet & 12 months on top and basin(s).
- Caution boxes may be heavy and will require 2 people to lift.



Mac



Mac 1500 Double - 2024 (Wall Hung)

Cabinet Size: 1480mm (L) X 450mm (D) X 500mm (H)
 Top Size: 1500mm (L) X 460mm (D) X 20mm (H)
 Type: Wall Hung
 Basin: Client to nominate
 No Tap Holes, Tapware to be wall-mounted

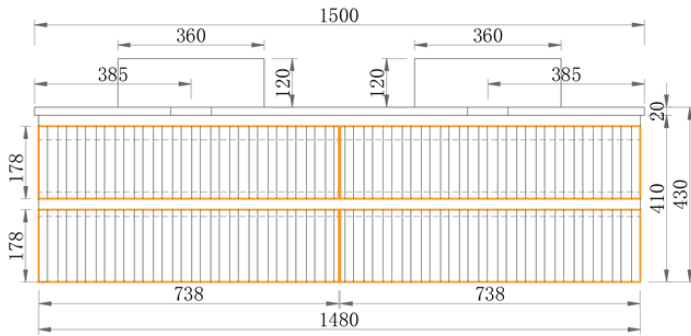
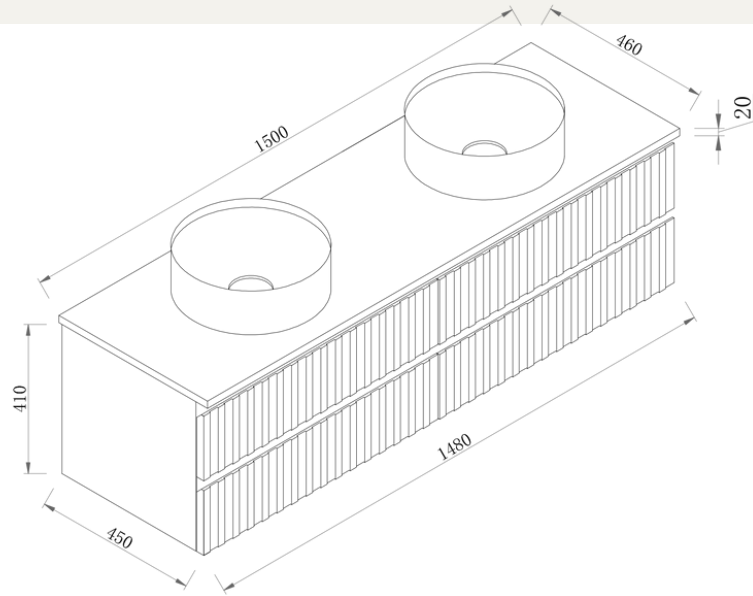

Front Elevation

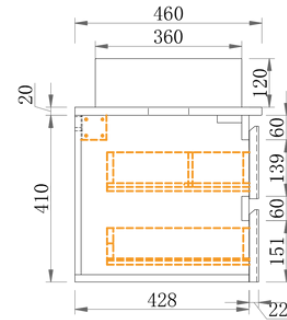

Section Side

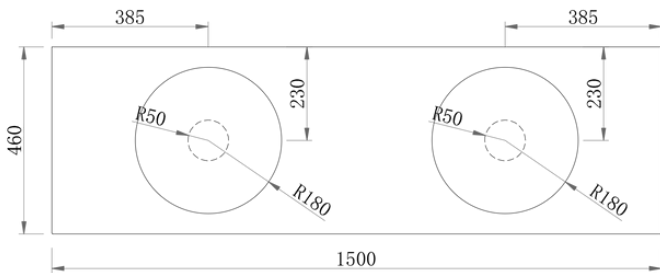

Top View

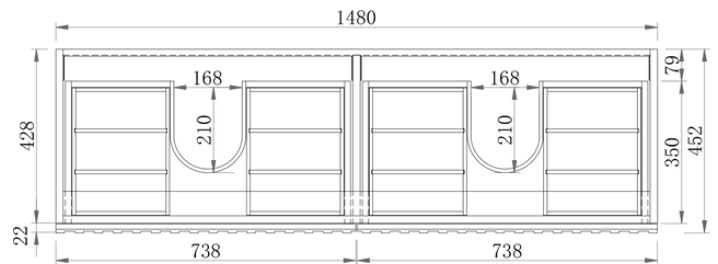

Section Top - Drawer Inserts

Notes:

- Wastes and faucets are not included.
- Vanity unit must be installed by a qualified tradesmen - Failure to do so will void the warranty.
- Plumbing fixtures must be installed by a qualified plumber - Failure to do so will void the warranty.
- Warranty information: 5 years on cabinet & 12 months on top and basin(s).
- Caution boxes may be heavy and will require 2 people to lift.



vanitybydesign.com.au



vanitybydesign_



TEL: 07 3376 6055



241 Monier Road
 Darra, QLD, 4076



Chelsea

Chelsea 460

Overall Size: 460mm (L) X 255mm (D) X 600mm (H)

Type: Wall-Hung

*Only Suitable for Mixer Tap

Finish - Natural, Japan Black & Custom Paint

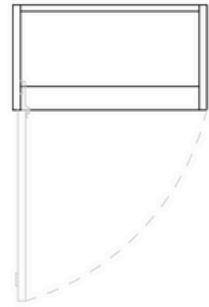
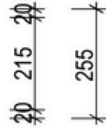
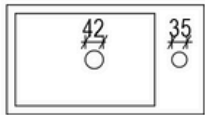
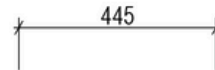
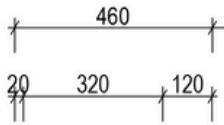
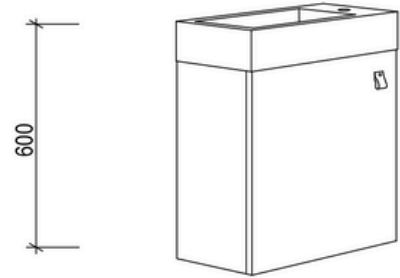

Top View

Section - Top

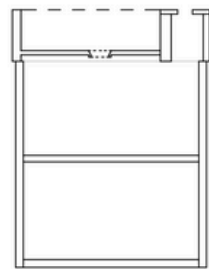
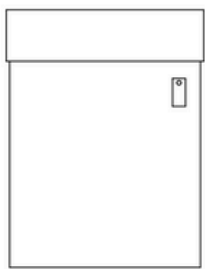
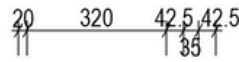
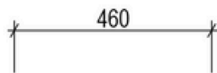

Front Elevation

Section

Notes:

- Wastes and faucets are not included.
- Vanity unit must be installed by a qualified tradesmen - Failure to do so will void the warranty.
- Plumbing fixtures must be installed by a qualified plumber - Failure to do so will void the warranty.
- Warranty information: 5 years on cabinet & 12 months on top and basin(s).
- Caution boxes may be heavy and will require 2 people to lift.



Vanity

BY DESIGN



vanitybydesign.com.au



[vanitybydesign_](https://www.instagram.com/vanitybydesign_)



TEL: 07 3376 6055



241 Monier Road
Darra, QLD, 4076