



V

Bondi

collection



House Collection

Bondi 1800 Double

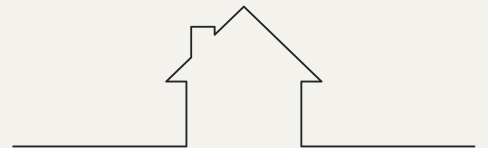

House Collection

Bondi 1800 Double



Cabinet Finish

Choose your paint finish | Custom Paint also available upon request

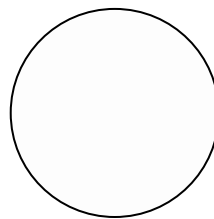

White

Bench Top

Subject to availability and chosen design



Italian Carrara
Natural Marble



Snow-Blanc
Crystalline Silica-Free
(Engineered Stone)

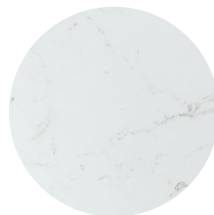

Ayla
Crystalline Silica-Free
(Engineered Stone)

Feet

Choose a finish

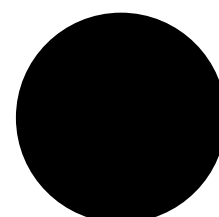

Matte Black

V

Bondi collection

– Picture a collision between abstract art and classic European Interior Design. Our playful creation features whimsically mismatched legs and panelled arch detailing on the front face, blurring the lines between traditional and contemporary aesthetics. Inspired by the vibrant spirit of Bondi, a popular Australian beach, this design is a bit out there, a touch loud, delightfully artistic, and unapologetically opinionated!

Bondi 1800 Double Basin
1800 Length x 563 Depth

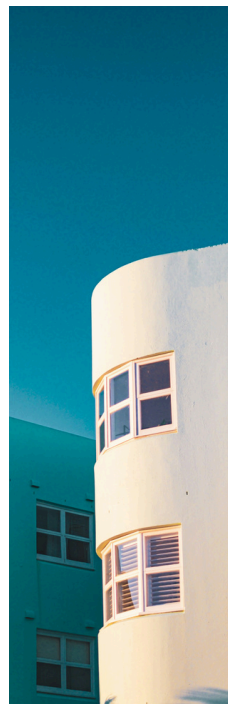

Bondi



Bondi 1800 Double - 2024

Cabinet Size: 1780mm (L) X 550mm (D) X 860mm (H)
 Top Size: 1800mm (L) X 563mm (D) X 20mm (H)
 Type: Freestanding
 Basin: Round Under-mount Ceramic Basins
 Splash-back: Optional

Tap Hole: Client to nominate

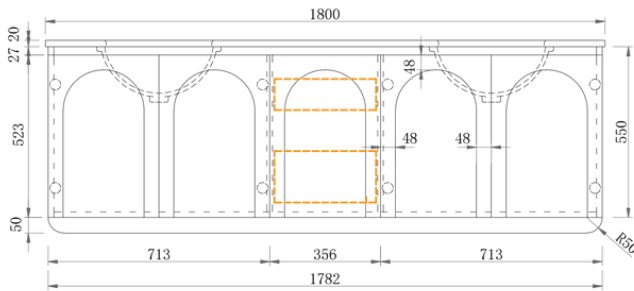
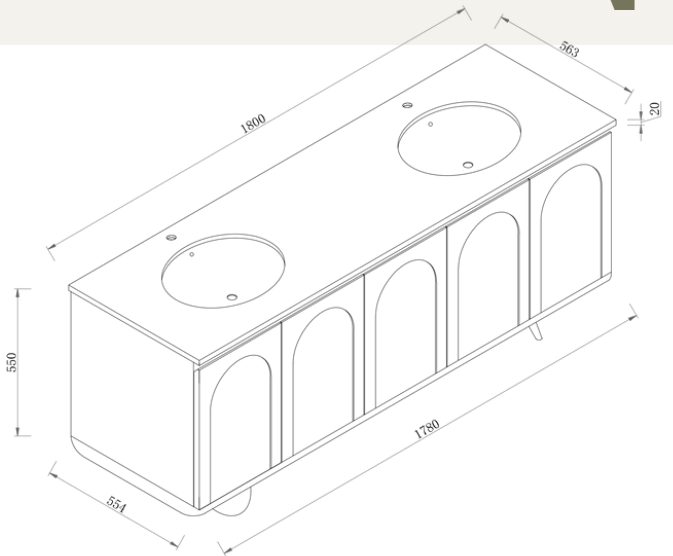

Front Elevation

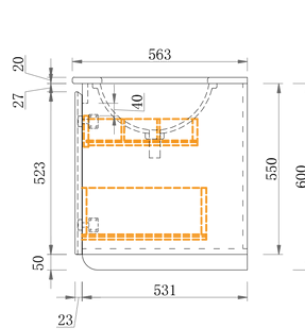

Section Side

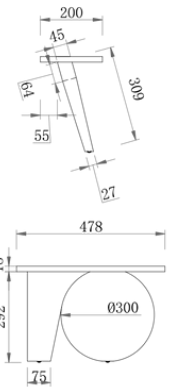

Leg Detail

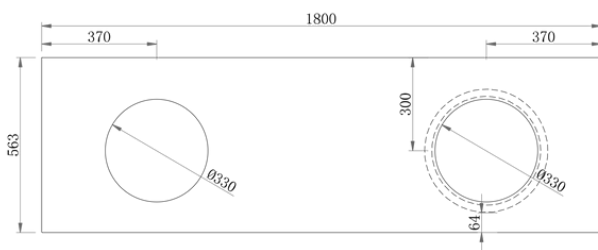

Top View

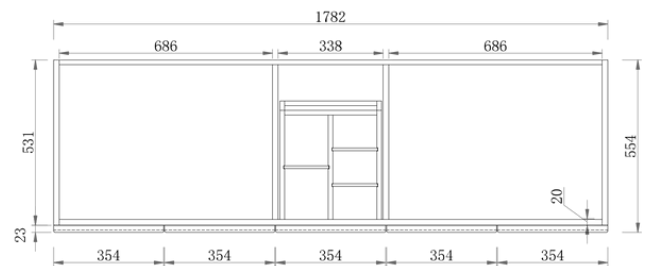

Section Top - Drawer Inserts

Notes:

- Wastes and faucets are not included.
- Vanity unit must be installed by a qualified tradesmen - Failure to do so will void the warranty.
- Plumbing fixtures must be installed by a qualified plumber - Failure to do so will void the warranty.
- Warranty information: 5 years on cabinet & 12 months on top and basin(s).
- Caution boxes may be heavy and will require 2 people to lift.



vanitybydesign.com.au



vanitybydesign_



TEL: 07 3376 6055



241 Monier Road
 Darra, QLD, 4076



vanitybydesign.com.au



[vanitybydesign_](https://www.instagram.com/vanitybydesign_)



TEL: 07 3376 6055



241 Monier Road
Darra, QLD, 4076